

HYDRAULICKÝ ROZVADĚČ CETOP5 DSG-03-***

**ROZMĚRY**

str. 2/8

PRŮTOKOVÝ DIAGRAM

str. 3/8

VARIANTA AC TLAK

str. 4/8

VARIANTA DC,R,RQ TLAK

str. 6/8

OBJEDNÁČÍ KLÍČ

str. 8/8

**PRO VÍCE PODROBNĚJŠÍCH TECHNICKÝCH
INFORMACÍ KATALOG ZDE:**

<https://www.yuken.cz/ke-stazeni>

INTERFLUID spol. s r.o.

1.Máje 3381/106

Ostrava Moravská Ostrava, 703 00

Otevírací doba: 7:00 - 15:30

(po-pá mimo svátky)

Kontakty:

Tel.: + 420 595 953 879

Fax: + 420 595 955 908

interfluid@interfluid.com

obchod@interfluid.com

Bankovní spojení:

CZK: 27-7357520297 / 0100

IBAN : CZ560100000277357520297

EUR:34278-522852761 / 0100

IBAN : CZ8301000342780522852761

www.interfluid.comPartner v oblasti hydrauliky a
pneumatiky.Už více jak 20 let tvoříme řešení na
míru vašim potřebám.

ROZMĚRY

● Models with AC Solenoids: DSG-03- *** -A* - $\frac{N}{N1}$ -50/5090

The position of the Plug-in connector can be changed as illustrated below by loosening the lock nut. After completion of the change, be sure to tighten the lock nut with the torque as specified below.

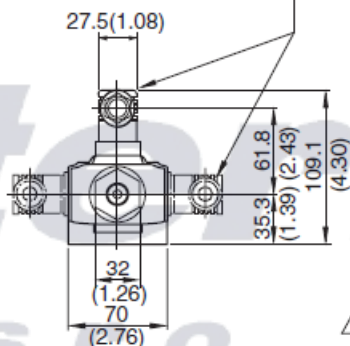

Cable Departure
 Cable Applicable:
 Outside Dia. 8-10mm (.31-.39 in.)
 Conductor Area Not Exceeding 1.5mm² (.0023 Sq. in.)

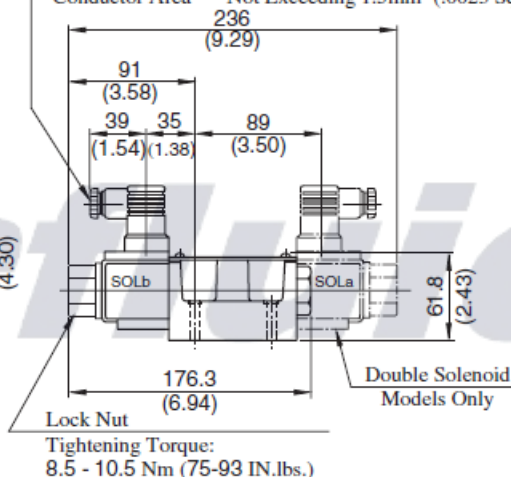

● Models with DC Solenoids: (S-)DSG-03- *** -D* - $\frac{N}{N1}$ -50/5090

● Models with R Type Solenoids: (S-)DSG-03- *** -R* -N-50/5090

The position of the Plug-in connector can be changed as illustrated below by loosening the lock nut. After completion of the change, be sure to tighten the lock nut with the torque as specified below.

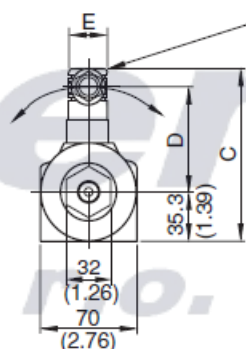

Cable Departure
 Cable Applicable:
 Outside Dia. 8-10mm (.31-.39 in.)
 Conductor Area Not Exceeding 1.5mm² (.0023 Sq. in.)

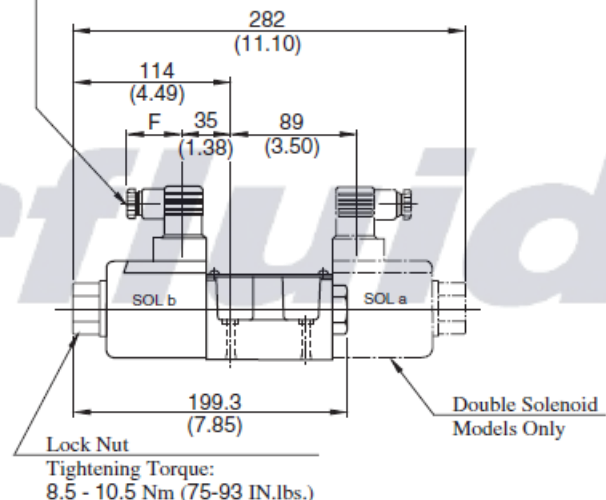

PRŮTOKOVÝ DIAGRAM

● Standard Type: DSG-03

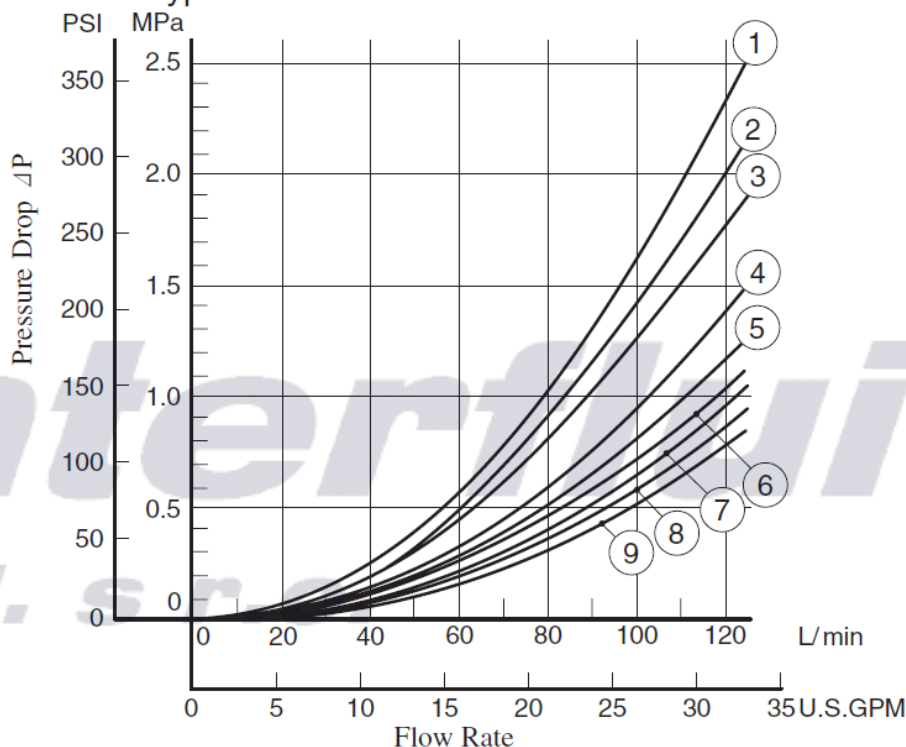

Model Numbers	Pressure Drop Curve Number				
	P→A	B→T	P→B	A→T	P→T
DSG-03-3C2	⑦	⑦	⑦	⑦	—
DSG-03-3C3	⑨	⑨	⑨	⑨	⑤
DSG-03-3C4	⑦	⑧	⑦	⑧	—
DSG-03-3C40	⑦	⑦	⑦	⑦	—
DSG-03-3C5	⑨	⑦	⑦	⑨	①
DSG-03-3C60	⑥	⑤	⑥	⑤	①
DSG-03-3C9	⑨	⑦	⑨	⑦	—
DSG-03-3C10	⑦	⑧	⑦	⑦	—
DSG-03-3C11	⑨	⑦	⑦	⑦	—
DSG-03-3C12	⑦	⑦	⑦	⑧	—
DSG-03-2D2	④	③	⑥	⑥	—
DSG-03-2B2	②	①	⑦	⑦	—
DSG-03-2B3	③	②	⑨	⑨	—
DSG-03-2B8	⑥	—	⑤	—	—

VARIANTA AC

● Models with AC Solenoids: DSG-03-***-A*

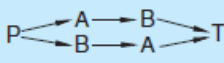
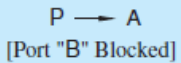
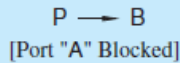
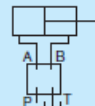
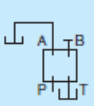
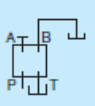
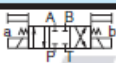
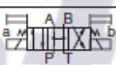
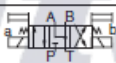
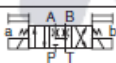
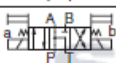
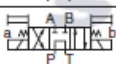
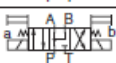
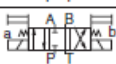
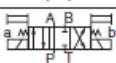
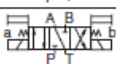
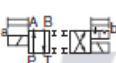
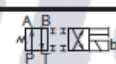
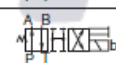
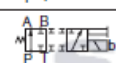
No. of Valve Positions	Spool-Spring Arrangement	Model Numbers	Graphic Symbols	Max. Flow L/min											
															
															
				Working Pressure MPa				Working Pressure MPa				Working Pressure MPa			
10 16 25 31.5				10 16 25 31.5				10 16 25 31.5							
Three Positions	Spring Centred	DSG-03-3C2		100	100	100	100	100(70)	100(48)	96(28)	65(24)	100(70)	100(48)	96(28)	65(24)
		DSG-03-3C3		90	90	90	90	100(81)	100(81)	100(81)	100(81)	100(81)	100(81)	100(81)	100(81)
		DSG-03-3C4		80	80	80(65)	80(25)	100(58)	100(33)	76(22)	46(19)	100(58)	100(33)	76(22)	46(19)
		DSG-03-3C40		100	100	100	100	100(75)	100(62)	100(39)	84(21)	100(75)	100(62)	100(39)	84(21)
		DSG-03-3C5		30	30	30	30	26	21	18	16	30	28	28	28
		DSG-03-3C60		70	70	70	—	100	100	100	—	100	100	100	—
		DSG-03-3C9		100	100	100	100	60	60	60	60	60	60	60	60
		DSG-03-3C10		80	80	80(30)	80(20)	100(55)	100(36)	60(21)	34(16)	100(55)	100(36)	60(21)	34(16)
		DSG-03-3C11		100	100	100	100	100(80)	100(65)	85(35)	62(28)	100(80)	100(65)	85(35)	62(28)
		DSG-03-3C12		90	90	90(30)	90(20)	100(55)	100(36)	60(21)	34(16)	100(55)	100(36)	60(21)	34(16)
		Two Positions	No-Spring Detented	DSG-03-2D2		100	100	100	100	40	40	30	28	60	60
Spring Offset	DSG-03-2B2				100	100	100	100	34	24	20	19	100(62)	100(62)	100(44)
	DSG-03-2B3			100	100	100	100	57	57	57	57	100(79)	100(72)	100(64)	100(59)
	DSG-03-2B8			—	—	—	—	26	19	18	16	100(35)	87(15)	61(9)	49(7)

Notes : 1. The relation between the maximum flow in the table above and the frequency/voltage (within the serviceable voltage) is as shown below.





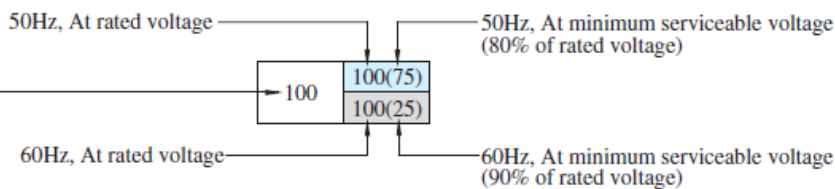

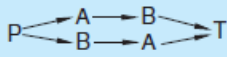
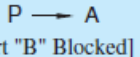

(Example)

The maximum flow rate is constant regardless of 50 Hz or 60 Hz and of any voltage variants within the serviceable voltage

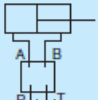
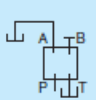
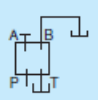
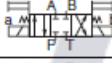
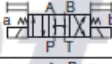
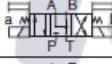
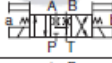
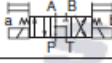
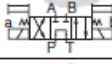
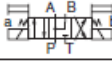
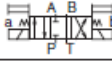
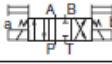

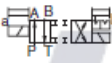
VARIANTA AC

● Models with AC Solenoids: DSG-03-***-A*

No. of Valve Positions	Spool-Spring Arrangement	Model Numbers	Graphic Symbole	Max. Flow U.S.GPM											
								 [Port "B" Blocked]				 [Port "A" Blocked]			
															
				Working Pressure PSI				Working Pressure PSI				Working Pressure PSI			
				1450	2320	3630	4570	1450	2320	3630	4570	1450	2320	3630	4570
Three Positions	Spring Centred	DSG-03-3C2		26.4	26.4	26.4	26.4	26.4 (18.5)	26.4 (12.7)	25.4 (7.4)	17.2 (6.3)	26.4 (18.5)	26.4 (12.7)	25.4 (7.4)	17.2 (6.3)
		DSG-03-3C3		23.8	23.8	23.8	23.8	26.4 (21.4)	26.4 (21.4)	26.4 (21.4)	26.4 (21.4)	26.4 (21.4)	26.4 (21.4)	26.4 (21.4)	26.4 (21.4)
		DSG-03-3C4		21.1	21.1	21.1 (17.2)	21.1 (6.6)	26.4 (15.3)	26.4 (8.7)	20.1 (5.8)	12.2 (5.0)	26.4 (15.3)	26.4 (8.7)	20.1 (5.8)	12.2 (5.0)
		DSG-03-3C40		26.4	26.4	26.4	26.4 (19.8)	26.4 (16.4)	26.4 (10.3)	22.2 (5.5)	12.7 (4.8)	26.4 (16.4)	26.4 (10.3)	22.2 (5.5)	12.7 (4.8)
		DSG-03-3C5		7.9	7.9	7.9	7.9	6.9	5.5	4.8	4.2	7.9	7.4	7.4	7.4
		DSG-03-3C60		18.5	18.5	18.5	—	26.4	26.4	26.4	—	26.4	26.4	26.4	—
		DSG-03-3C9		26.4	26.4	26.4	26.4	15.9	15.9	15.9	15.9	15.9	15.9	15.9	15.9
		DSG-03-3C10		21.1	21.1	21.1 (7.9)	21.1 (5.3)	26.4 (14.5)	26.4 (9.5)	15.9 (5.5)	9.0 (4.2)	26.4 (14.5)	26.4 (9.5)	15.9 (5.5)	9.0 (4.2)
		DSG-03-3C11		26.4	26.4	26.4	26.4	26.4 (21.1)	26.4 (17.2)	22.5 (9.2)	16.4 (7.4)	26.4 (21.1)	26.4 (17.2)	22.5 (9.2)	16.4 (7.4)
		DSG-03-3C12		23.8	23.8	23.8 (7.9)	23.8 (5.3)	26.4 (14.5)	26.4 (9.5)	15.9 (5.5)	9.0 (4.2)	26.4 (14.5)	26.4 (9.5)	15.9 (5.5)	9.0 (4.2)
Two Positions	No-Spring Detented	DSG-03-2D2		26.4	26.4	26.4	26.4	10.6	10.6	7.9	7.4	15.9	15.9	10.6	9.2
	Spring Offset	DSG-03-2B2		26.4	26.4	26.4	26.4	9.0	6.3	5.3	5.0	26.4 (16.4)	26.4 (16.4)	26.4 (11.6)	24.8 (9.8)
		DSG-03-2B3		26.4	26.4	26.4	26.4					15.1	15.1	15.1	15.1
		DSG-03-2B8		—	—	—	—	6.9	5.0	4.8	4.2	26.4 (9.2)	23 (4.0)	16.1 (2.4)	12.9 (1.8)

Notes: 1. The relation between the maximum flow in the table above and the voltage (within the serviceable voltage) is as shown below.

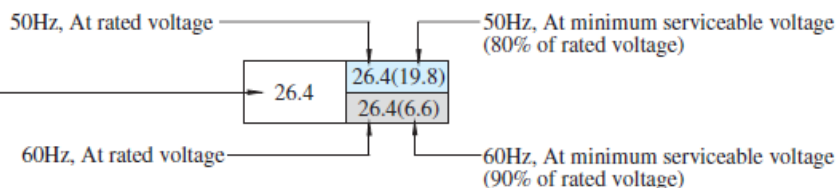

(Example)

The maximum flow rate is constant regardless of 50 Hz or 60 Hz and of any voltage variants within the serviceable voltage

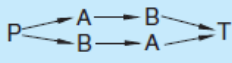
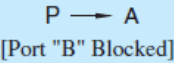
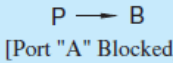
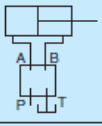
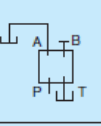
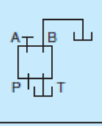
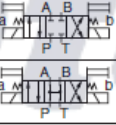
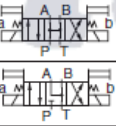
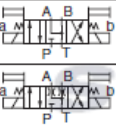
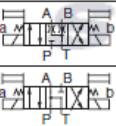
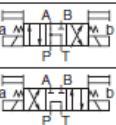
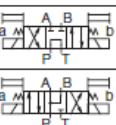
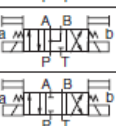
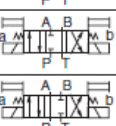
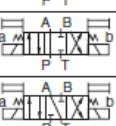

VARIANTA DC,R,RQ

- Models with DC Solenoids: DSG-03-***-D*
- Models with R Type Solenoids: DSG-03-***-R*
- Models with RQ Type Solenoids: DSG-03-***-RQ100*

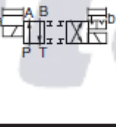
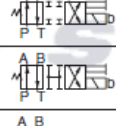
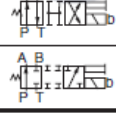
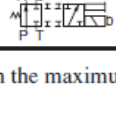
No. of Valve Positions	Spool-Spring Arrangement	Model Numbers	Graphic Symbols	Max. Flow L/min												
																
																
				Working Pressure MPa				Working Pressure MPa				Working Pressure MPa				
				10	16	25	31.5	10	16	25	31.5	10	16	25	31.5	
Three Positions	Spring Centred	DSG-03-3C2		120	120	120	120	120	120	80	55	120	120	80	55	
		DSG-03-3C3		120	120	120	120	120	120	120	120	120	120	120	120	
		DSG-03-3C4		120	120	120	120	120	120	84	64	120	120	84	64	
		DSG-03-3C40		120	120	120	120	120	120	62	49	120	120	62	49	
		DSG-03-3C5		50	50	50	50	35	24	21	20	45	45	45	45	
		DSG-03-3C60		120	120	120	—	120	120	120	—	120	120	120	—	
		DSG-03-3C9		120	120	120	120	100	100	100	100	100	100	100	100	
		DSG-03-3C10		120	120	120	65	120	112	60	51	120	112	60	51	
		DSG-03-3C11		120	120	120	120	100	100	80	65	100	100	80	65	
		DSG-03-3C12		120	120	120	65	120	120	62	51	120	120	62	51	
Two Positions	No-Spring Detented	DSG-03-2D2		120	120	120	120	45	37	30	28	60	60	40	35	
		Spring Offset	DSG-03-2B2		110	110	110	110	68	47	38	38	120	114	75	63
			DSG-03-2B3		120	120	120	120	77	77	77	77	120	83	58	48
			DSG-03-2B8		—	—	—	—	53	33	24	23	120	120	120	120

Notes) 1. The relation between the maximum flow in the table above and the voltage (within the serviceable voltage) is as shown below.

INTERFLUID spol. s r.o.

1.Máj 3381/106

Ostrava Moravská Ostrava, 703 00

Otevírací doba: 7:00 - 15:30

(po-pá mimo svátky)

Kontakty:

Tel.: + 420 595 953 879

Fax: + 420 595 955 908

interfluid@interfluid.com

obchod@interfluid.com

Bankovní spojení:

CZK: 27-7357520297 / 0100

IBAN : CZ560100000277357520297

EUR:34278-522852761 / 0100

IBAN : CZ8301000342780522852761







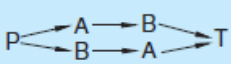
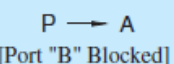
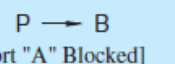
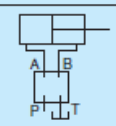
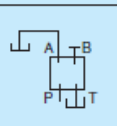
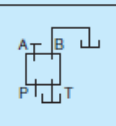

www.interfluid.com

Partner v oblasti hydrauliky a
 pneumatiky.

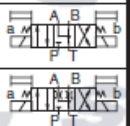
Už více jak 20 let tvoříme řešení na
 míru vašim potřebám.

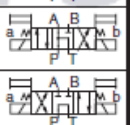
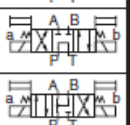
VARIANTA DC,R,RQ

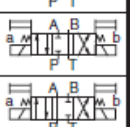
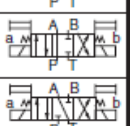
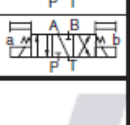
- Models with DC Solenoids: DSG-03-***-D*
- Models with R Type Solenoids: DSG-03-***-R*
- Models with RQ Type Solenoids: DSG-03-***-RQ100*

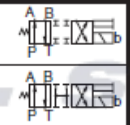
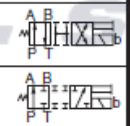
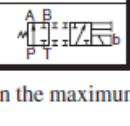
No. of Valve Positions	Spool-Spring Arrangement	Model Numbers	Graphic Symbols	Max. Flow U.S. GPM				Max. Flow U.S. GPM				Max. Flow U.S. GPM			
								 [Port "B" Blocked]				 [Port "A" Blocked]			
															
				Working Pressure PSI				Working Pressure PSI				Working Pressure PSI			
				1450	2320	3630	4570	1450	2320	3630	4570	1450	2320	3630	4570
Three Positions	Spring Centred	DSG-03-3C2		31.7	31.7	31.7	31.7	31.7	31.7	21.1	14.5	31.7	31.7	21.1	14.5
		DSG-03-3C3		31.7	31.7	31.7	31.7	31.7	31.7	31.7	31.7	31.7	31.7	31.7	31.7
		DSG-03-3C4		31.7	31.7	31.7	31.7	31.7	31.7	22.2	16.9	31.7	31.7	22.2	16.9
		DSG-03-3C40		31.7	31.7	31.7	31.7	31.7	31.7	16.4	12.9	31.7	31.7	16.4	12.9
		DSG-03-3C5		13.2	13.2	13.2	13.2	9.2	6.3	5.5	5.3	11.9	11.9	11.9	11.9
		DSG-03-3C60		31.7	31.7	31.7	—	31.7	31.7	31.7	—	31.7	31.7	31.7	—
		DSG-03-3C9		31.7	31.7	31.7	31.7	26.4	26.4	26.4	26.4	26.4	26.4	26.4	26.4
		DSG-03-3C10		31.7	31.7	31.7	17.2	31.7	31.7	15.9	13.5	31.7	31.7	15.9	13.5
		DSG-03-3C11		31.7	31.7	31.7	31.7	26.4	26.4	17.2	13.7	26.4	26.4	17.2	13.7
		DSG-03-3C12		31.7	31.7	31.7	17.2	31.7	31.7	16.4	13.5	31.7	31.7	16.4	13.5
Two Positions	No-Spring Detented	DSG-03-2D2		31.7	31.7	31.7	31.7	11.9	9.8	7.9	7.4	15.9	15.9	10.6	9.2
	Spring Offset	DSG-03-2B2		29.1	29.1	29.1	29.1	18	12.4	10	10	31.7	30.1	19.8	16.6
		DSG-03-2B3		31.7	31.7	31.7	31.7	20.3	20.3	20.3	20.3	31.7	31.7	31.7	31.7
		DSG-03-2B8		—	—	—	—	14	8.7	6.3	6.1	31.7	31.7	16.4	12.4

Notes) 1. The relation between the maximum flow in the table above and the voltage (within the serviceable voltage) is as shown below.

(Example)

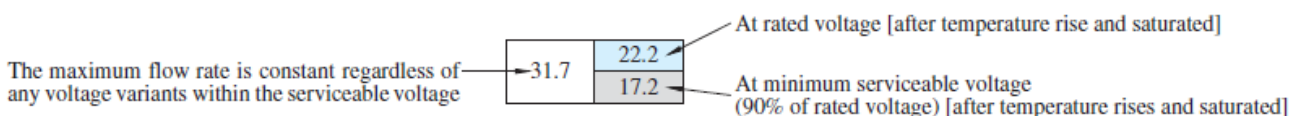

INTERFLUID spol. s r.o.

1. Máje 3381/106
Ostrava Moravská Ostrava, 703 00
Otevírací doba: 7:00 - 15:30
(po-pá mimo svátky)

Kontakty:

Tel.: + 420 595 953 879
Fax: + 420 595 955 908
interfluid@interfluid.com
obchod@interfluid.com

Bankovní spojení:

CZK: 27-7357520297 / 0100
IBAN : CZ560100000277357520297
EUR: 34278-522852761 / 0100
IBAN : CZ8301000342780522852761

www.interfluid.com

Partner v oblasti hydrauliky a pneumatiky.
Už více jak 20 let tvoříme řešení na míru vašim potřebám.

OBJEDNÁČÍ KLÍČ

F-	S-	DSG	-03	-2	B	2	A	-D24	-C	-N	-50	*	-L
Special Seals	Shockles Type	Series Number	Valve Size	Number of Valve Positions	Spool-Spring Arrangement	Spool Type	Special Two Position Valve (Omit if not required)	Coil Type	Manual Override	Electrical Conduit Connection	Design Number	Design Standard	Models with Reverse Mtg. of Solenoid (Omit if not required)
F: For Phosphate Ester Type Fluids (Omit if not required)	None: Standard Type	DSG: Solenoid Operated Directional Valve	03	3: Three Positions	C: Spring Centred	2, 3 4, 40 5, 60 9, 10 11, 12	—	AC: A100 A120 A200 A240 DC: D12 D24 D100 R: (AC→DC) R100 R200 RQ: (AC→DC) RQ100	None: Manual Override Pin	None: Terminal Box Type	50	None: Japanese Std. "JIS" 90: N.American Design Std.	—
				2: Two Positions	D: No-Spring Detented	2	—	RQ: (AC→DC) RQ100					L
				B: Spring Offset	2 3 8	A ⁺¹ B ⁺¹	C: Push Button and Lock Nut (Option)		N: ⁺² Plug-in Connector Type NI: ⁺³ Plug-in Connector Type with Indicator Light (Option)	None: Japanese Std. "JIS" and European Design Std. 90: N.American Design Std.		—	
S: Shockles Type			3: Three Positions	C: Spring Centred	2 4	—		R: (AC DC) R100 R200 RQ: (AC DC) RQ100					
				2: Two Positions	B: Spring Offset	2	A ⁺¹ B ⁺¹						L

★ 1. In case of the special two position valve, please refer to [page 369](#) for details.

★ 2. N is not available for RQ-type solenoids.

★ 3. NI is not available for R and RQ-type solenoids.

PŘEDBĚŽNÁ DOLOŽKA:

Tento technický list byl vypracován dle nejlepších vědomostí a s obzvláštní pečlivostí. Poskytované informace se zakládají na praktických zkušenostech, interních zkouškách a odrážejí naši současnou úroveň znalostí. Jsou určeny pouze pro informaci a nepředstavují záruku vlastností výrobku nebo jeho vhodnosti pro konkrétní použití. Za chyby tisku a norem a za omyly nelze převzít jakoukoliv záruku. Platí naše Všeobecné obchodní podmínky

INTERFLUID spol. s r.o.

1.Máje 3381/106
 Ostrava Moravská Ostrava, 703 00
 Otevírací doba: 7:00 - 15:30
 (po-pá mimo svátky)

Kontakty:

Tel.: + 420 595 953 879
 Fax: + 420 595 955 908
 interfluid@interfluid.com
 obchod@interfluid.com

Bankovní spojení:

CZK: 27-7357520297 / 0100
 IBAN : CZ560100000277357520297
 EUR:34278-522852761 / 0100
 IBAN : CZ8301000342780522852761

www.interfluid.com

Partner v oblasti hydrauliky a pneumatiky.
 Už více jak 20 let tvoříme řešení na míru vašim potřebám.